

# Zip FlushMaster<sup>®</sup> Solo

Water Saver Urinal Flushing System  
Keeps Urinals Clean & Reduces Water Wastage

**Affix Model Number Label Here**  
**86826**



## Table of Contents

Key Features .....	3
Read These Warnings First .....	3
Check Your Package .....	3
Installation Procedure .....	3
Set Up Water Discharge .....	4
Airbreak Installation .....	4
Install Sensor .....	5
Connect Latching Valve Cable .....	6
Set Flush Timing .....	7
Maintenance Instructions .....	8
Completing Installation .....	8
Problem Solving .....	9
End of life disposal .....	10
Notes pages .....	11
Contact Details .....	12

## Accessories

You will need one of these accessories (not included in the package).



99026 Zip FlushMaster Direct Injection Airbreak 1.50 inch BSP/ 38 mm

99025 Zip FlushMaster Direct Injection Airbreak 1.25 inch BSP/ 32 mm

99024 Zip FlushMaster Direct Injection Airbreak 1.00 inch BSP / 25 mm

NOTE: You may need the following (not included with this kit)

- 1) Isolation valve
- 2) 350 kPa Pressure reduction valve

## Key Features

One of the world's most effective, ceiling recessed, urinal flushing systems.  
This unit is supplied with a power pack for connection to 220-240 volt AC power.  
Smart Demand electronic programming allows for a variable flush cycle to meet your needs precisely.  
Narrow sensitivity beam protects against unwanted flushing operations.

## Read These Warnings First



Read all instructions before attempting to install this system.  
Never attempt to install this system without reading all instructions.  
This unit is designed for indoor use only and should never be installed outdoors or exposed to the elements of nature. This unit must not be positioned in an area that may be cleaned by a water jet. This unit must not be cleaned with a water jet.  
All plumbing connections must be made in accordance with AS/NZS3500 and installation with AS/NZS3500.2.  
Supply pressure 350kPa - 700kPa ( see recommendations on P7 )

## Check Your Package

Zip FlushMaster Solo package includes.



Zip FlushMaster Solo WS005 Product Code 42214:

Ceiling recessed Solo sensor complete with latching valve, power pack and plumbing

## Installation Procedure

1. Set up water discharge with isolating valve, Latching Valve and Airbreak
2. Install sensor
3. Connect latching valve cable
4. Set flush timing

Isolation:

An Isolation valve (not supplied) must be fitted, in an accessible position, upstream of this installation.

## Set Up Water Discharge

Typical Installation with Direct Injection: Model WS005

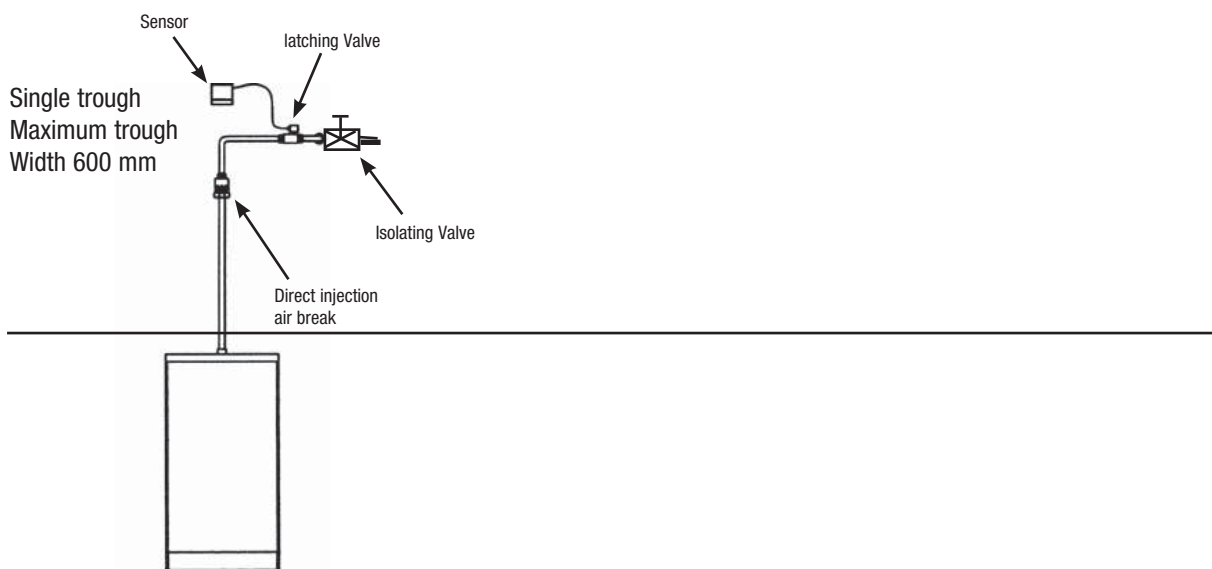
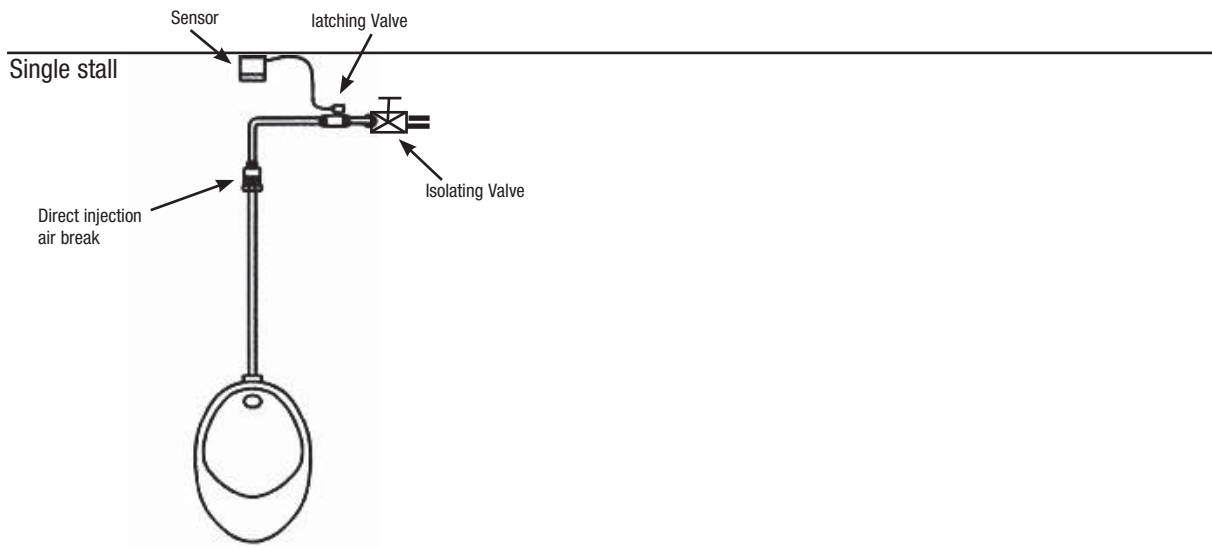

## Airbreak Installation.



- The air break must be fitted in a vertical position. Fitting in a position other than vertical will result in leakage.
- Fit the air break to the top of the urinal sparge pipe (in place of a cistern), as shown in the diagram. Locate as high as possible.
- Do not use sealing tape in the air break joints. The fittings in the latching valve will require the use of sealing tape.
- Supply and install a half-inch pipe from the top of the air break, to the outlet side of the latching valve.
- Securely fix the piping to the wall as per AS/NZS3500 to prevent possible tampering and vandalism.

## Install Sensor

### Typical Installation with Ceiling Recessed Sensor (Model WS005)

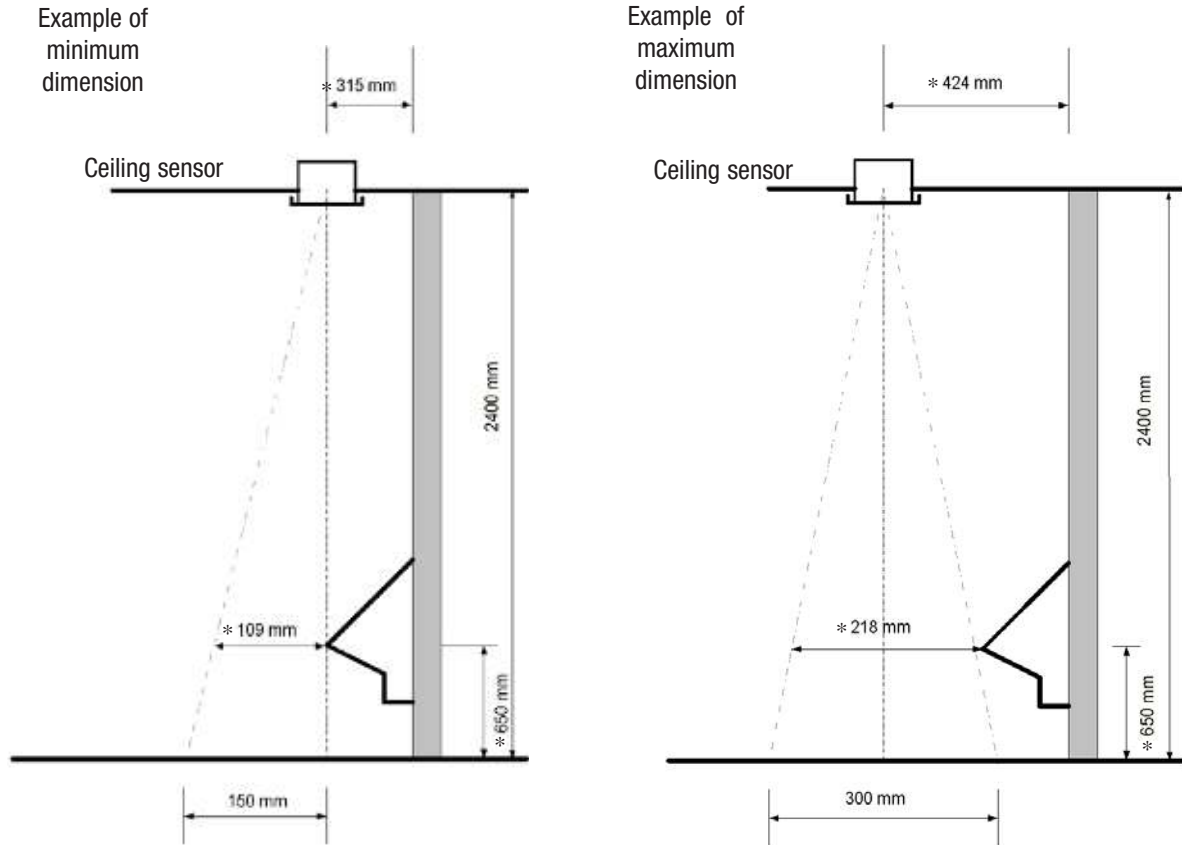

NOTE: \* dimensions may change depending on type and position of urinal.

Position the centre of the ceiling sensor within \*109 mm from the front of the urinal (as shown above).

Typical sensor coverage from a 2400 mm ceiling will be less than 300 mm in front of the urinal. This is important to avoid false activation of the flushing program.

To install the ceiling recessed sensor, cut a 64 mm diameter hole in the ceiling.

Use the inbuilt clips to fasten the sensor housing in place when inserted into the hole.

If any of the cable connecting the sensor to the latching valve is visible, shield it with conduit.

Warning. Do not connect the power pack until all plumbing connections are completed. The power must be connected last as connection activates the system test mode (see pages 6 & 7).

## Connect Latching Valve Cable

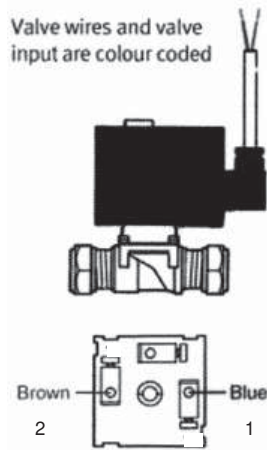

Run the latching valve cable to the sensor in conduit or within the building wall and ceiling.

Do not extend the cable as this will affect correct operation.

Locate plug on cable from the latching valve and detach it from circuit board.

The plug should be lifted directly upwards.

Fasten the latching valve cable to the plug on the circuit board by first removing the plug from the board. Lift plug directly upwards and hold plug so fixing screws are facing you.

Thread the cable through one of the holes in the the sensor lid,

Secure the brown cable into the right hand screw terminal and tighten.

Secure the blue cable into the left hand screw terminal and tighten.

Push the plug into the socket on the circuit board, positioned so screws face towards the centre of the board.

Finally, insert the cable from the power pack into the circuit board inlet socket

Once the power is connected, the system can be tested by operating in test mode.(see page 7)

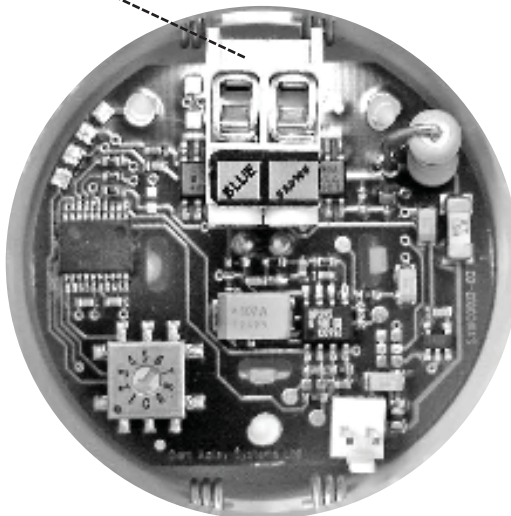
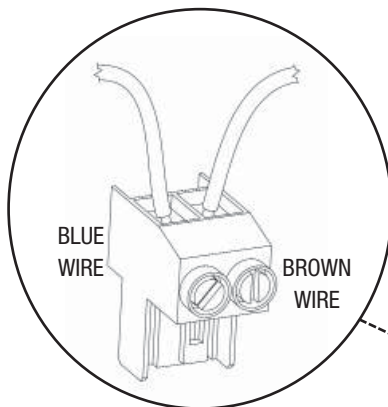

## Set Flush Timing

### NOTE:

Units supplied with a YELLOW rotary switch, will not have a test mode.

For these units Position 0 will be non functional

### Test mode:

The rotary switch on the board is marked 0 to 9

Position 0 is test mode, where the system will operate automatically for a number of cycles.

### Operational mode:

Positions 1 to 9 are flush times in seconds (i.e. Valve opening times).

When first powered the sensor will wait 2.5 minutes and then calibrate it's surroundings, after this period it will be ready to detect.

### Setting Flush Time:

The beam from the sensor is very narrow so care should be taken when installing so that it is mounted above the urinal where the user would be.

The sensor will only accept someone as a user if they stand under the beam for 5 seconds or more, when the user walks away there is a 3 second delay and it will flush for the time you have set on the rotary switch.

The unit can only be used with the supplied power pack.

Mount the sensor away from lights, hot pipes, ceiling transformers and direct sunlight.

Do not touch components on the board with your fingers.

If the water pressure is greater than 700 kPa then a 350 kPa pressure reducing valve must be fitted upstream of the latching valve.

Adjust the timing of the flush to ensure an adequate flush, by setting the flush switches on the sensor board (see diags. below)

When setting the fill time ensure the water does not backup the connection pipe and spill out of the Air break. If the water is overflowing, or close to overflowing, reduce the fill time, or pressure. Alternatively, fit a 6 l/m flow restrictor.

### Recommended flush settings:

The recommended setting for a single urinal is No.2, when supplied with 350 kPa water pressure. (see notes on page 11)

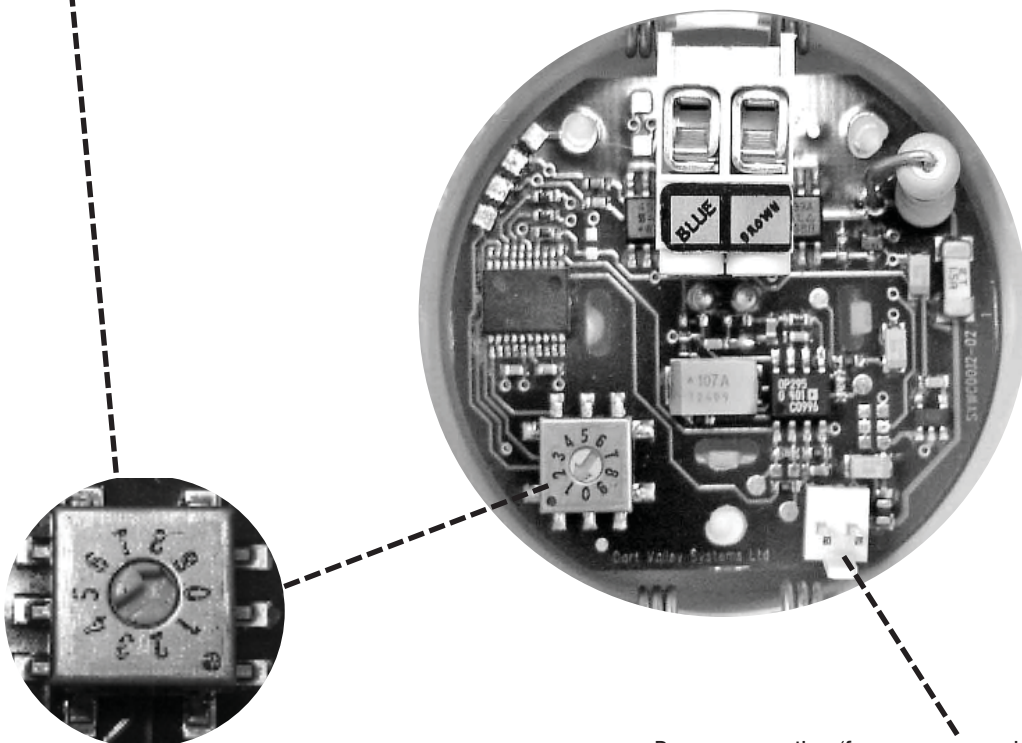

Flush time selection (Seconds)

Power connection (from power supply)

## Maintenance Instructions

### Cleaning

Keep the openings in the face of the sensor clear of dirt.

Never clean the case with strong or abrasive cleaners.

Wipe with a soft cloth, warm water and dish washing liquid.

Never hose or spray any part of the flushing system.

However to avoid the inconvenience associated with any malfunction of the flushing system, it is recommended that the latching valve diaphragm be replaced annually.

The power must be turned off at the power point before any form of maintenance is attempted.

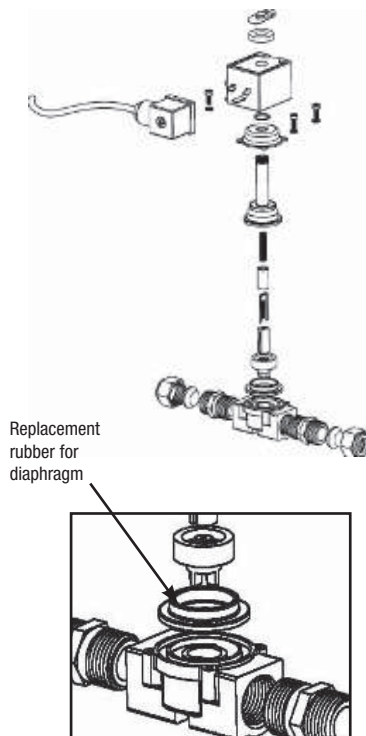

### Valve Diaphragm Replacement

Isolate power and water supply.

Remove fixing clip on top of latching valve coil by levering up clip with screw driver and clicking back until clip releases from shaft.

Lift coil, spring clip and spacer from latching valve shaft.

Carefully undo the 4 screws retaining the valve housing. When the last screw is about to be released, grip the valve body and top section as it is spring loaded.

Carefully separate the top section containing the spring and plungers from the lower body. The diaphragm should now be visible. Lift it out of position.

Remove the centre plastic piece from the rubber diaphragm. Fit the new diaphragm to the plastic centre. Replace it in the same orientation. The centre plastic piece and the new diaphragm have two breather holes, try to align these together when reinstalling a new diaphragm.

Re-assemble in the reverse of above. Note the position of all parts in the diaphragm for correct assembly. To order quote Zip part number 90279 Diaphragm Kit.

## Completing Installation

After setting the desired filling time (p.7), Fit the sensor to the ceiling and wipe clean the outer surfaces.. Turn on the power and wait for 2.5 minutes. After this time the system will be ready to detect users



## Problem Solving

Symptoms	Possible Causes	Suggested Action
System does not flush.	Water supply turned off. Latching valve installed backwards. Latching valve cable damaged or latching cable unplugged. Latching valve faulty. Sensor not activating. Not sensing user	Check water supply, turn on tap. Reinstall latching valve correctly. Check cable and replug into sensor circuit board. Replace latching valve. Check sensor as below. Must be visible for 5 sec, or more
System flushes too long.	Sensor duration time set incorrectly.	Reset flush dial to a lower number See page 7
System flushes for a short period of time.	Sensor duration time set incorrectly.	Reset flush dial to a higher number See page 7
Sensor not active	Wrong ceiling position	Reposition sensor. See page 5
No Power	Faulty GPO or household fuse Faulty power supply	Contact an electrician Replace power pack
System flushes continually except for time set as duration 'on' period.	Sensor cable wires crossed. Reversed valve polarity	Uncross latching wire connection. Change positions 1 & 2 on socket (P6)
System continually flushes.	Valve diaphragm split latching valve faulty	Replace diaphragm. See page 8 Replace latching valve
Flushing will not stop.	False activation. Sensor not activating.	Check for sensor vibration. Check sensor as below.
Sensor not activating.	Power turned off. Damaged sensor Sensor lens blocked. Faulty sensor.	Turn on power. Replace Sensor Clean sensor lens Replace sensor.

## End of life disposal

In order to help preserve our environment we ask that you dispose of this product correctly. Please contact your local city council for collection centre details

### WELS Ratings:

This system, when tested with a Caroma Leda urinal achieves a 4 Star WELS rating. In order to maintain the WELS ratings for alternative urinals, the flushMaster must be set to deliver the correct volume of water as specified by the urinal manufacturer.

## NOTES

## Contact Details

### Head Office

Zip Heaters (Aust) Pty. Ltd.  
ABN 46 000 578 727  
67 Allingham Street  
Condell Park NSW 2200  
Postal: Locked Bag 80  
Bankstown 1885 Australia

Website: [www.zipheaters.com](http://www.zipheaters.com)  
Facsimile: (02) 9796 3858  
Telephone: (02) 9796 3100  
Free Call: 1 800 638 633



As Zip policy is one of continuous product improvement, changes to specifications may be made without prior notice. Images in this booklet have been modified and may not be true representations of the finished goods