

ANX 211 RHD ATON SINK

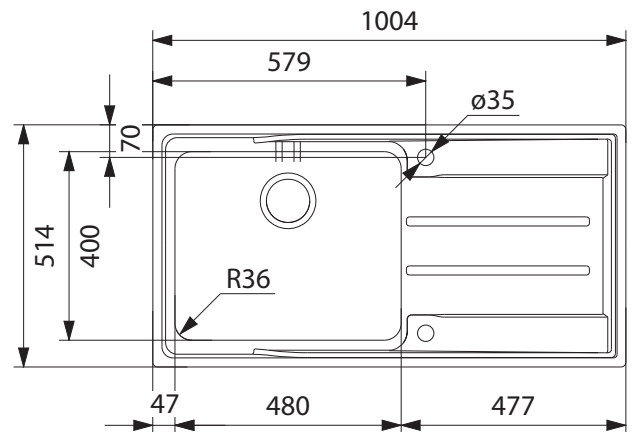

PRODUCT INFORMATION

| | |
|-------------------------|--|
| Installation | Topmount/Flushmount |
| Dimensions | 1004(W) x 514(H)mm |
| Cabinet Base | 600mm |
| Bowl Size | 480(W) x 400(H) x 190(D)mm/36L |
| Bowl Radius | 36mm |
| Cut-Out Size | Topmount: 995 x 506mm, cr=20 Flushmount: utilise DXF file |
| Cut-Out Template | Yes |
| Waste Outlet | Semi Integrated Waste |
| Overflow | Yes |
| Tap Holes | ø35mm |
| Remote Waste | Yes |
| Finish | Stainless Steel |



1 ACCESSORIES AVAILABLE **1** ACCESSORIES INCLUDED

BARE SINK OPTION AND SOME SINK & TAP PACKAGES DO NOT INCLUDE ACCESSORIES.
PLEASE CHAT TO YOUR SALES CONSULTANT FOR FURTHER INFORMATION.

ACCESSORIES

- 1**



RM 42
Rollamat
- 2**



CB 104
Chopping Board
- 3**



SB 112
Strainer Bowl
- 4**



DB 448
Drainer Basket
- 5**



CR 113
Champagne Flute Rack
- 6**



DT 651
Extension Drainer

LAST UPDATED: 9 SEP 2020