

Brodware

PROGRESSIVE MIXER TECHNOLOGY

Progressive mixer technology introduces minimal, low-profile mixer designs. It allows the flow of water and temperature control to be simple and precise. Progressive mixers are designed and engineered to operate most effectively at full flow.

Flow rate is determined by water pressure except when used in conjunction with a restricted outlet. This is the case with fixtures which require WELS certified restrictors to be supplied. In these cases the restricted outlet will adjust and determine the flow rate.

HOW IT WORKS:

From the off position, turning clockwise will begin the flow of cold water. As the mixer approaches the mid-point, full flow is reached and hot water begins to mix, continuing until only hot water is flowing from the outlet.

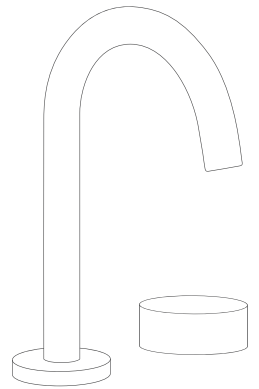

EXPLANATORY DIAGRAM:

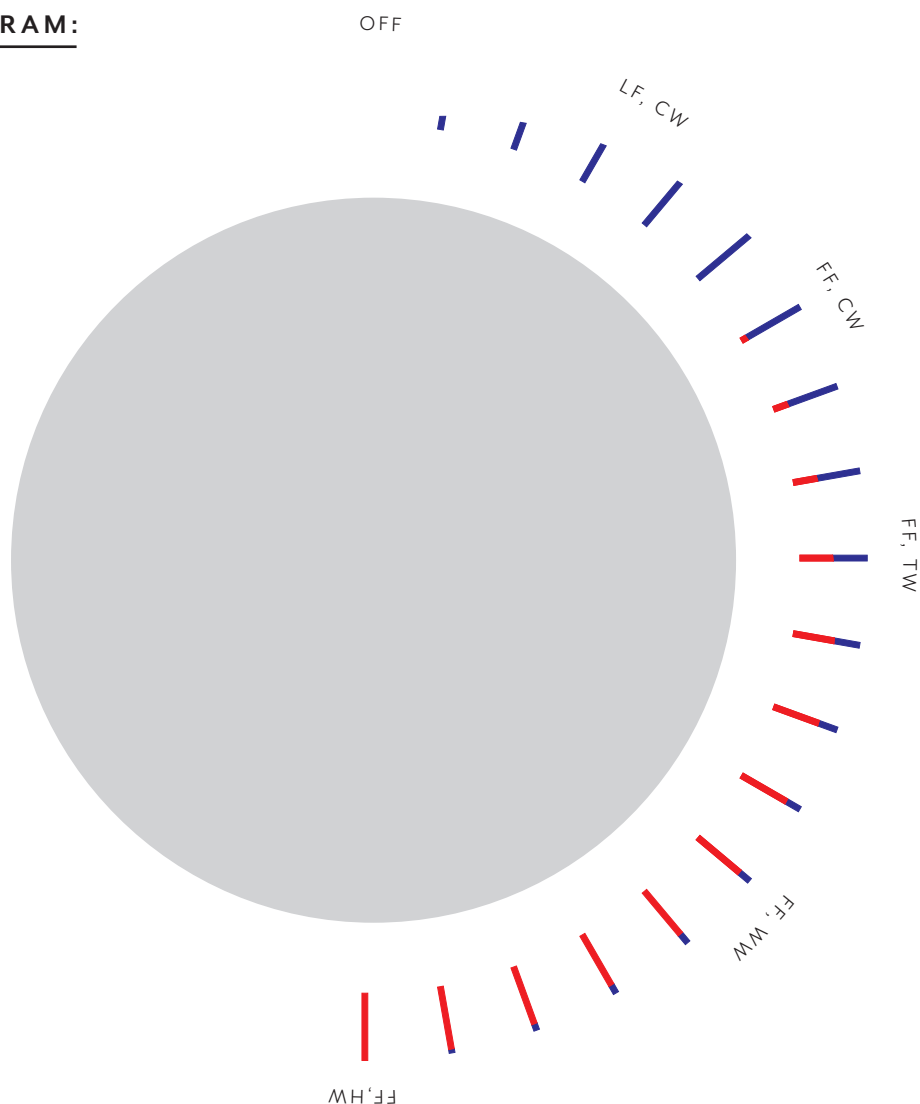

CODE BREAKDOWN

LF = LOW FLOW	TW = TEPID WATER
FF = FULL FLOW	WW = WARM WATER
CW = COLD WATER	HW = HOT WATER

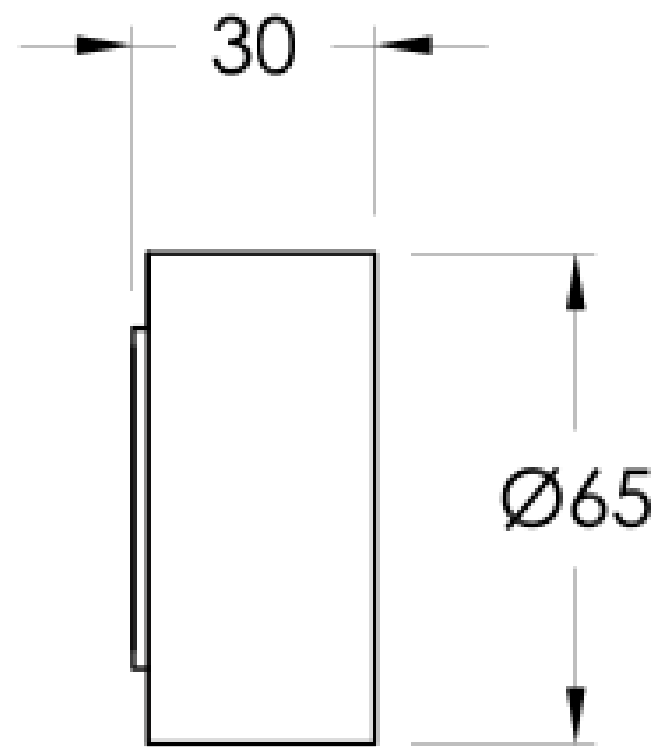

Brodware

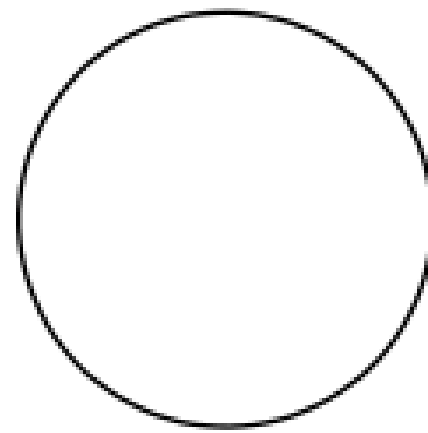

HALO

1.9547.00.0.XX

XX Indicates finish
Manufacturing engineers of quality commercial and residential fittings
Dimensions subjects to change without notice. All dimensions are approximate
Copyright © Brodware Pty Ltd 2018. www.brodware.com

Brodware

Brodware

1.9547.00 Progressive Wall Mixer Installation Guide

- 1) Ensure that the mixer body is installed with a distance of 53mm to 64mm from back of body to finished face (FIG. A)
- 2) As per (FIG. C), the hot feed port is on the left, the cold feed port is on the right, and the outlet port is pointing up. The mixer body should always be installed with the outlet port pointing up.
- 3) Flush water lines. Connect plumbing to mixer body. Ensure that the locknut for the cartridge is tight. Pressure test as per AS3500.
- 4) After sheeting off and tiling, fit the handle spacer to the handle and push back to the wall. The spindle can be cut down. Ensure that the handle spacer and handle will push back to the wall. Measure the distance between the handle and the wall, and cut the spindle to this length. Fit the handle and spacer to the spindle, and fit it back to wall.
- 5) Please refer to the Wall Mixer Instruction Booklet for all other technical information.

NOTE FOR INSTALLER:

- *With the handle fully rotated anti-clockwise, the unit is shut off. When the handle begins to rotate clockwise it begins to feed cold water. When the handle progresses to the middle, the hot water begins to mix. With the handle fully rotated clockwise, only hot water will be supplied. (FIG. B)
- *For servicing of the cartridge, turn off the water supply, unscrew the locknut from ontop of the cartridge and remove the cartridge. Do not overtighten the locknut when reinstalling. The locknut should be tightened up firm, but not excessively.
- *All tapware and plumbing must be tested before sheeting off / concealing, as per AS3500. This includes independently testing the hot and cold operation of the mixer.
- *Water pressure must not exceed 500kpa as per AS3500, or the product will not be warranted.
- *Ensure wall sheet and tiles have a Ø40mm hole around the mixer to allow for future serving.

ICPROG 20181101

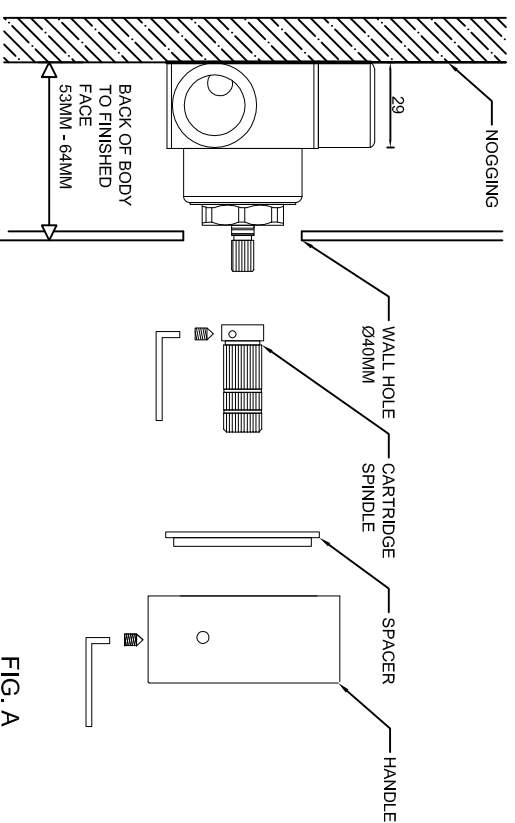

FIG. A

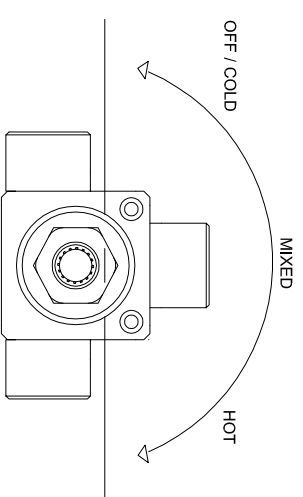

FIG. B

MIXER HANDLE OPERATION

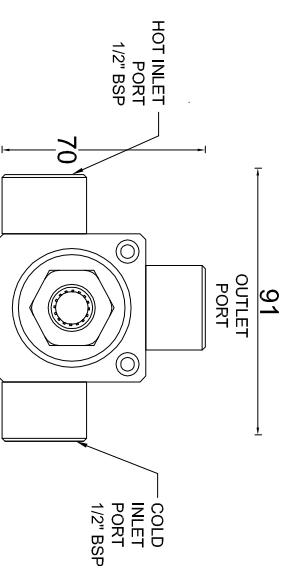

FIG. C

MIXER BODY INSTALLATION ORIENTATION