

1

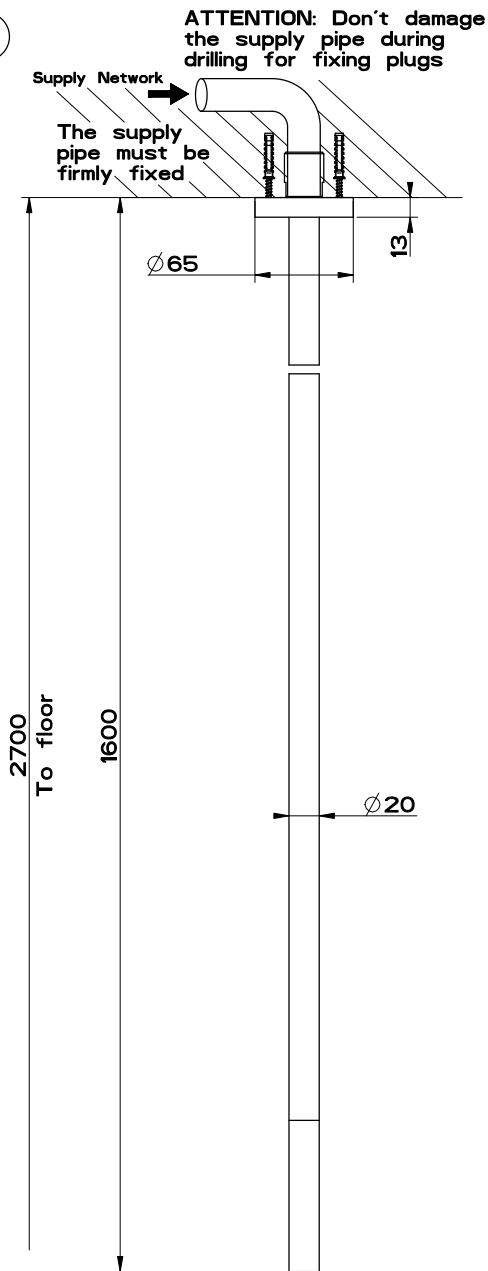

2

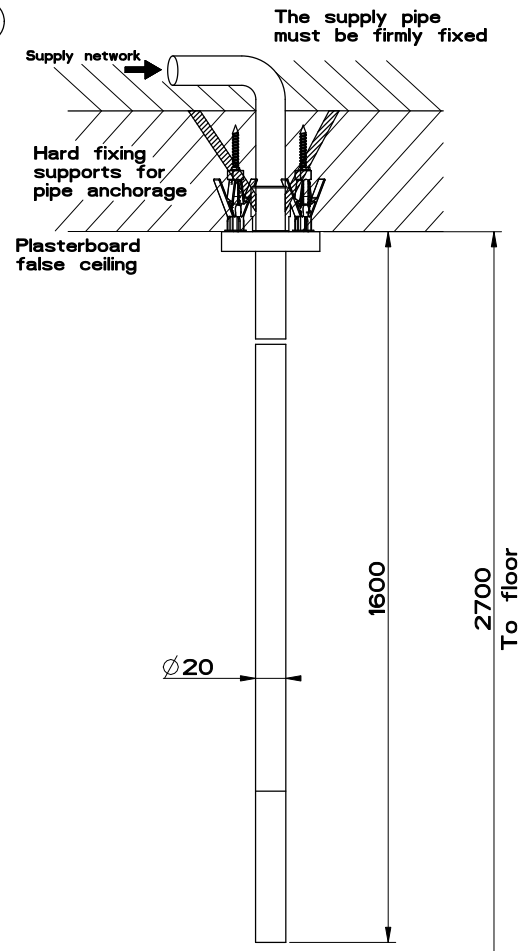

3

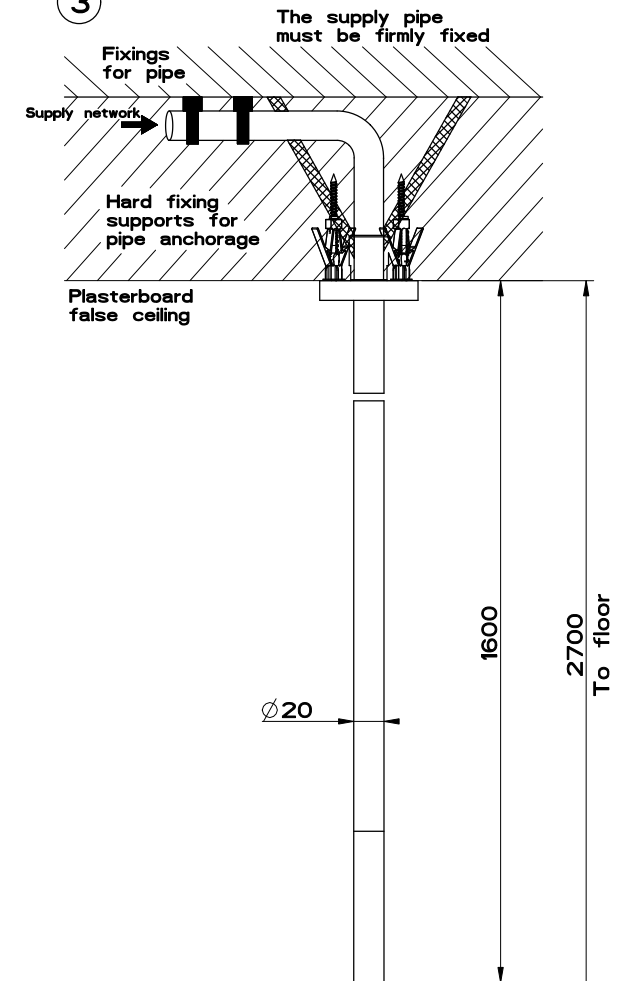

Caution:
In second and third case the rigid supports are not provided in the faucet box; the customer will have to make them before installation.

GESI

Gessi Sp.A. Parco Gessi, 13037 Serravalle Sesia (Vercelli) Italy
Tel.0039 0163 454111 Fax.0039 0163 453150
www.gessi.com e-mail: gessi@gessit febbraio 2017 copyright © GESSI Sp.A.

GESI316 54099

BOCCA A SOFFITTO L-1600

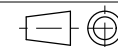

formato / size

A4

Rev.

0 0

codice cliente / client code

A004