

Spare part lists concealed toilet flushing cisterns:  
**FRIABLOC®/FRIASET/WIMO/FRIAPLAN®**

Universal flushing cisterns for top operation, large toilet operation panel: Model F 200, F 201

**Model F 200**  
 Ref.No. 3320xx

**Model F 201**  
 Ref.No. 332701



xx = Colourcode

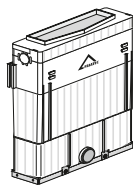

Ref.No. 322000 (850 mm) /  
 95.A03.00..0001  
 Ref.No. 322500 (1000 mm)  
 Ref.No. 322003  
 Ref.No. 324502

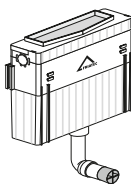

Ref.No. 302010 /  
 90.A16.00..0001

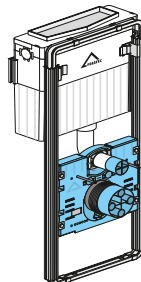

Ref.No. 352010  
 Ref.No. 352111  
 Ref.No. 354006  
 Ref.No. 042720 /  
 90.A18.00..0001

Ref.No. 319997 /  
 90.A11.00..0001  
 Ref.No. 322900  
 Ref.No. 323500 (1000 mm)  
 Ref.No. 323600 (850 mm)  
 Ref.No. 323601 /  
 95.A08.00..0001  
 Ref.No. 326900  
 Ref.No. 328800  
 Ref.No. 471037.00 /  
 PB.A47.10..3700

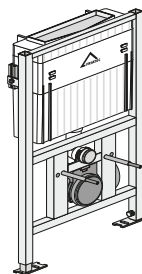
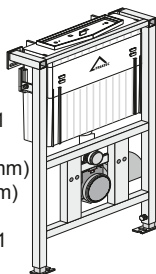

Ref.No. 300110 /  
 90.A02.00..0001

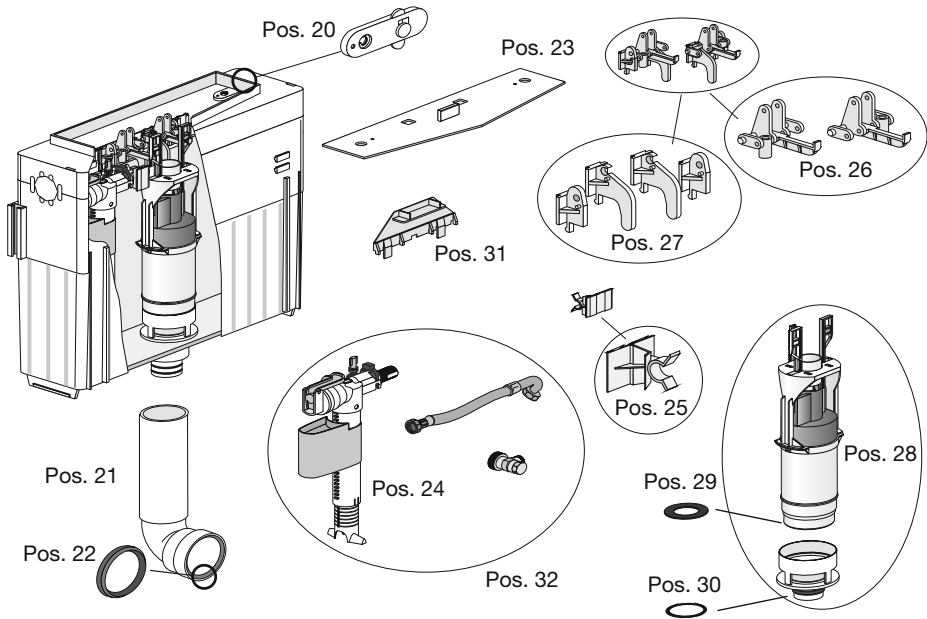
**Spare part lists concealed toilet flushing cisterns:  
 FRIABLOC®/FRIASET/WIMO/FRIAPLAN®**
**Interior – Universal flushing cisterns, top-operated**

Ref.No.	Line	Type	PU	Order qty (unit)
328000	20	Fixing flaps for control panel (1 set = 2 pieces)	1	
327500	21	Repair kit for flush pipe bend see following page	1	
334110	22	Lip sealing for flush pipe d 45	1	
320400	23	Cap for inspection opening protector	1	
327000	24	Hydraulic inlet valve	1	
322200	25	Bracket for inlet valve for top operated toilet modules	1	
322300	26	Operation for toilet outlet valve with threaded bush - top operated (1 set = 2 pieces)	1	
321200	27	Outlet valve fixing kit, top operated (1 set = 2 pieces)	1	
320800	28	Outlet valve with valve seat incl. bottom sealing and outlet gasket	1	
327700	29	Spare outlet gasket (da = 61 mm, di = 30 mm, t = 3 mm)	1	
334108	30	Rolling for bottom valve (45x4 mm)	1	
321505	31	Retention strip	1	
	32	Replacement: reinforced tube with knurled nut including hydraulic inlet valve and angle valve	1	

## Spare part lists concealed toilet flushing cisterns: FRIABLOC®/FRIAFIX®/FRIASET/ WIMO/FRIAPLAN®

### Flush pipe bend

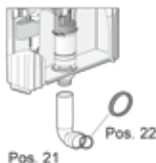
**Note:**

The flush pipe bend has to be shortened to the exact length.

Ref.No.	Line	Type	PU	Order qty (unit)
334046	21	Flush pipe bend since 11/2000 (= blue)	1	
327500	22	Lip sealing for flush pipe d 45	1	

### Inliner



Damage to the cistern body, regardless of what caused it, can be corrected promptly and without interfering with the existing tiling.

**Consisting of:**

- complete cistern liner (called „Inliner“ here) including bottom valve and O-ring
- 2 clamping rings (1 large, 1 small)
- FRIATEC drain fitting, with a shortened siphon
- 3 labels

Ref.No.	Type	PU	Order qty (unit)
321210	Inliner	1	
321202	Outlet valve for Inliner	1	

### Model F 200 – large toilet operation panels for top-operation, two-button version

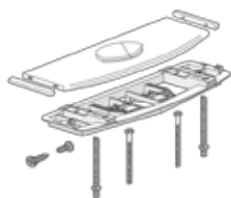

consisting of:

- operation panel with two buttons for spring-mounted dual-volume flushing
- installation frame, including anti-removal lock
- fixing material

Ref.No.	Type	PU	Order qty (set)
332001	01-alpine white, glossy	1	
330201	Special colours price-range I	1	

### Spare part lists concealed toilet flushing cisterns: FRIABLOC®/FRIASET/WIMO/FRIAPLAN®

#### Accessories for model F 200, F 201

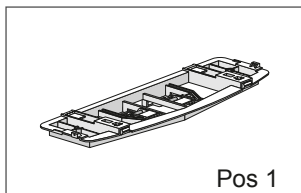

Pos 1

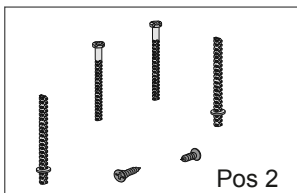

Pos 2

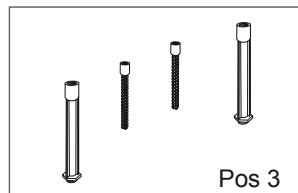

Pos 3

Ref.No.	Line	Type	PU	Order qty (unit)
334011	1	Frame complete for top operated panel	1	
334006	2	Kit of operation and fixing bolts and self-tapping screws for top operated panel (1 set = 2 pieces)	1	
339100	3	Extension set (5 - 15 cm) for model F 200, F 201	1	

#### Additional spare parts – Universal flushing cisterns Ref.No. 302010

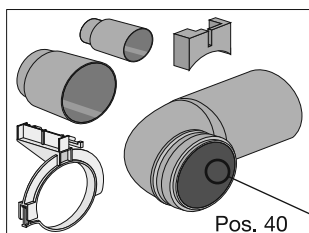

Pos. 40

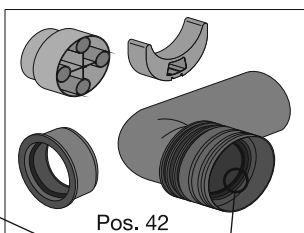

Pos. 42

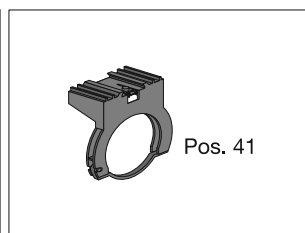

Pos. 41

Ref.No.	Line	Type	PU	Order qty (unit)
334096 <sup>1)</sup>	40	Toilet outlet bend d 90/110 with protective plug - not for FRIAPLAN	1	
334017	44	Lip sealing d 90 for outlet bend and connection bend	1	

<sup>1)</sup> to be discontinued

## Overview operation panels

## Product overview and measures

## Large toilet operation panels for front operation

[cm]

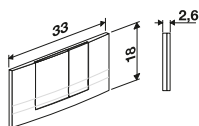

F 102

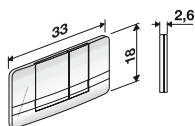

F 500

## Small toilet operation panels for front operation

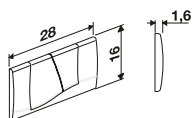

F 300

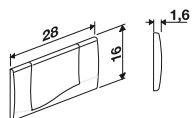

F 301

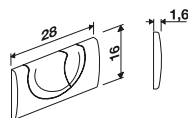

F 302

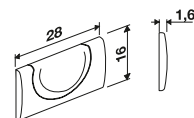

F 303

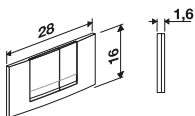

F 304

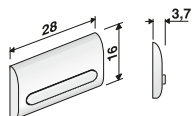

F 401

## Toilet operation panels for top operation

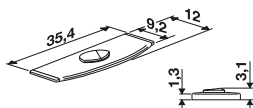

F 200

## Urinal operation panel for manual actuation, IR actuation (6V or 230V)

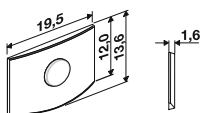

Ref.No. 33 61 xx  
Manual actuation

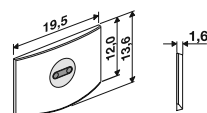

Ref.No. 33 71 xx  
IR actuation 6 V or 230 V