

SUB UNDERMOUNT BASINS





The Sub undermount basin collection comprises of timeless designs, which can be adapted to a range of bathroom settings. From the sharp lines of the rectangle basin to the smooth edges of the soft square, the Sub basins will enhance any daily bathroom routine to a luxurious feeling. The design can be further refined by pairing the basin with a solid surface top for a seamless design.

Manufactured from solid surface it has a smooth matt finish that is exceptionally hard wearing and durable.

Each Sub basin is supplied with pop-up waste and white solid surface plug.

Round

SPECIFICATIONS

Finishes:	White
Material:	Matt Solid surface
Overflow:	Yes
Tap Holes:	No
Waste Size:	32mm
Waste Supplied:	Yes - 32/40mm with pop up waste and white solid surface plug
Weight:	5.5kg
Bowl Capacity:	8L

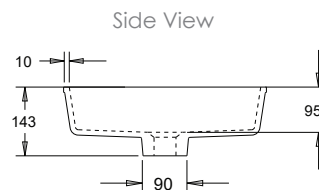
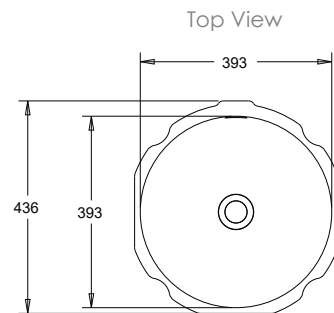

Sub Undermount Features

- Matt White
- Overflow
- Includes white solid surface plug

Dimensions are shown in millimetres. Due to the handcrafted nature of Omvivo products measurements are subject to a +/- 5mm manufacturing tolerance.

Smooth Square

SPECIFICATIONS

Finishes:

White



Material:

Matt Solid surface

Overflow:

Yes

Tap Holes:

No

Waste Size:

32mm

Waste Supplied:

Yes - 32/40mm with pop up waste and white solid surface plug

Weight:

4.6kg

Bowl Capacity:

6L

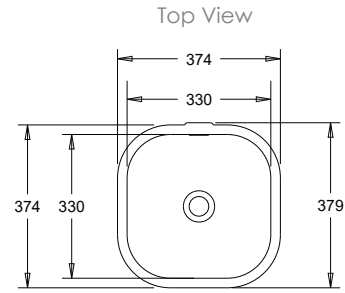

Side View

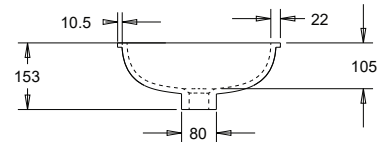

Rectangle

SPECIFICATIONS

Finishes:

White



Material:

Matt Solid surface

Overflow:

Yes

Tap Holes:

No

Waste Size:

32mm

Waste Supplied:

Yes - 32/40mm with pop up waste and white solid surface plug

Weight:

7.7kg

Bowl Capacity:

10L

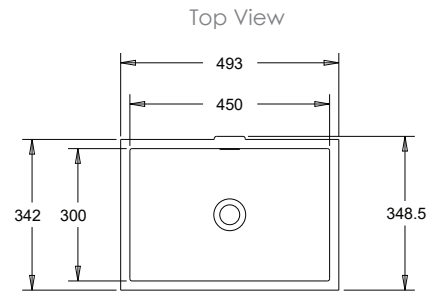

Side View

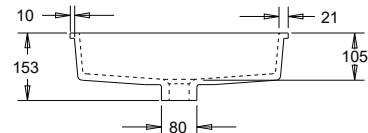

Stadium

SPECIFICATIONS

Finishes:

White



Material:

Matt Solid

Overflow:

Yes

Tap Holes:

No

Waste Size:

32mm

Waste Supplied:

Yes - 32/40mm with pop up waste and white solid surface plug

Weight:

6.7kg

Bowl Capacity:

9L

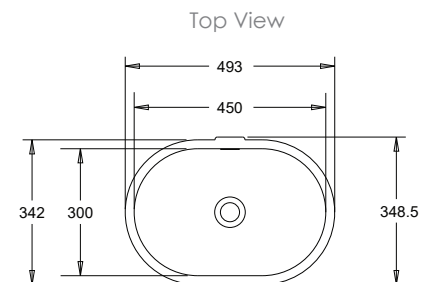

Side View

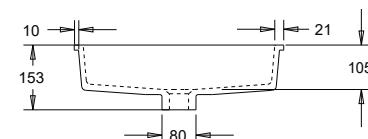

Dimensions are shown in millimetres. Due to the handcrafted nature of Omvivo products measurements are subject to a +/- 5mm manufacturing tolerance.

